

ZENON PILECKI*

Methodology for A-1 motorway basement treatment effectiveness improvement by means of geophysical methods in the areas of metal ores shallow mining threatened with the sinkhole occurrence in the Upper Silesia

Introduction

In the areas threatened with the occurrence of discontinuous deformations a good interaction of the basement with a civil structure, e.g. a motorway structure, may be difficult. To prevent the effects of the sinkhole process it is required to treat the basement and to protect the structure in a special way. The treatment needs selecting such a method, which would allow effectively improving the deformation-mechanical properties in the damage zones in the rock mass. This could be carried out using various methods: backfilling, mechanical or making special engineering protective structures.

The backfilling method is most frequently used to reduce the sinkhole threat from voids and loose zones of mining and geological origin. This method improves unfavorable stress and deformation state in the medium and thereby limits the development of damage processes in the mass rock, reducing the probability of discontinuous deformations occurrence on the ground surface. The selection of basement treatment technology must consider geological and mining conditions and the type of structures design on the ground surface.

Based on the experience so far in various geological-mining conditions in the Upper Silesia, a special methodology of injection works using geophysical methods was prepared (Kubański 2007; Pilecki et al. 2007) to treat the A-1 motorway basement in the section from Pyrzowice to Stolarzowice.

* Doc. dr hab. inż., AGH University of Science and Technology, Cracow; Mineral and Energy Economy Research Institute, Polish Academy of Sciences, Cracow.

At the preliminary stage, the scope and specific nature of basement treatment works results from the geophysical and geological-engineering recognition performed with regard to the occurrence of voids and loose zones in the rock mass (Popiołek, Pilecki 2005; Marcak, Pilecki 2006). This recognition, in the case of threatened sections of A-1 motorway, allowed determining 95 geophysical anomalies, which have been classified acc. to the reasons of their occurrence as follows:

- anomalies of mining origin related to the existence of vertical and horizontal mining workings as well as voids and loose zones generated in the rock mass due to the development of sinkhole processes,
- anomalies resulting from the covered civil structures in post-mining areas,
- anomalies of geological origin resulting from karsts phenomena, various geological forms like troughs, channels etc. filled with material of density different than that of the surrounding environment.

In the areas of anomalies found and in places of sinkhole and parts of post-mining infrastructure facilities observed on the ground surface, indicating the existence of shafts and small shafts in the past, a few hundred points were determined to perform injection holes. A larger number of holes were designed in places, where foundations of various civil structures of A-1 motorway are to be situated.

The basement treatment works are performed in the basic stage. The treatment methodology uses geophysical measurements mainly by means of gravimetric, georadar and micro camera methods. This study aimed at presentation of geophysical works methodology for optimal basement treatment in A-1 motorway sections. This description was preceded by a characteristic of sinkhole threat in A-1 motorway areas and by assumptions of basement treatment methodology. The paper does not discuss the results of treatment works but only their methodology.

1. The characteristic of sinkhole threat in the areas of shallow historical metal ores mining within the Bytom basin

Sections of A-1 motorway, threatened with discontinuous deformations, are situated in the areas of shallow historical zinc, lead and iron ores mining between Myszkowice and Stolarzowice (Pilecki, Kotyrba 2008; Pilecki 2008).

The size and type of discontinuous deformations was characterised based on the analysis of 121 descriptions of sinkhole documented in the period 1963–2007, mainly in studies of ZGH “Orzeł Biały” (Bratasz et al.1990). While carrying out the analysis the discontinuous deformations were broken down into those occurring in shafts and small shafts as well as those related to hard coal mining impact.

Fig. 1.1 presents the frequency of discontinuous deformations occurrence, distinguishing sinkhole in shafts in the period 1963–2007. Between 1978 and 1987 four sinkhole cases were added each year, because the source information referred only to a total number of 40

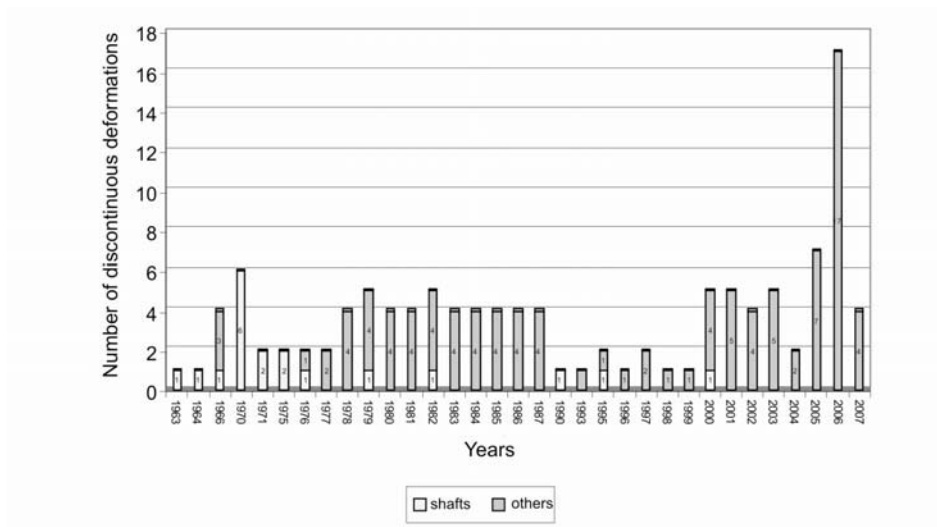

Fig. 1.1. Occurrence of discontinuous deformations in the area of Bytom basin in the period 1963–2007

Rys. 1.1. Występowanie deformacji nieciągłych na terenie niecki bytomskiej w latach 1963–2007

sinkhole cases recorded in that period and it is unknown, in what part it covered sinkhole cases in shafts. Since 2001 there has been no information on the occurrence of sinkhole in shafts. However, the information clearly indicates an increase in discontinuous deformations related to the impact of hard coal seams mining (Fig. 1.2).

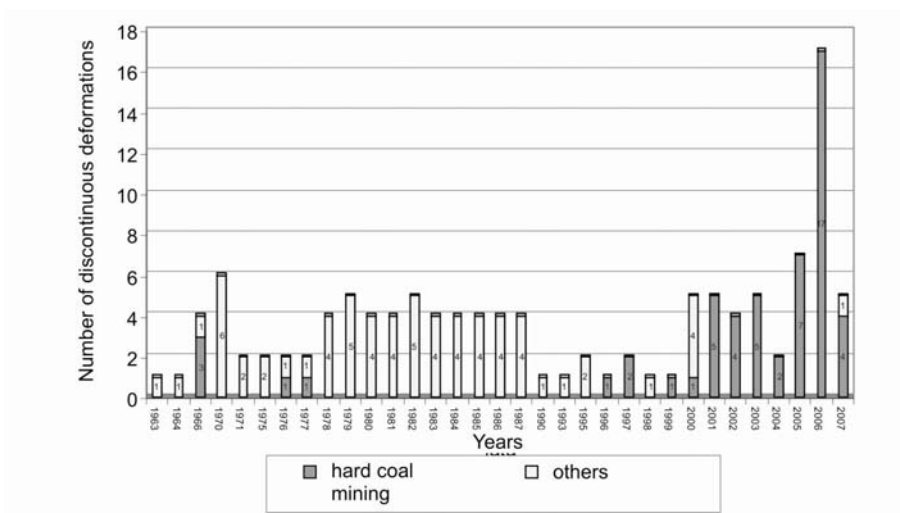

Fig. 1.2. Occurrence of discontinuous deformations within the Bytom basin taking into account the impact of hard coal seams mining in the period 1963–2007

Rys. 1.2. Występowanie deformacji nieciągłych na terenie niecki bytomskiej z uwzględnieniem oddziaływania eksploatacji pokładów węgla kamiennego w latach 1963–2007

In general, sinkhole cases were oval in shape or close to rectangular in the case of occurrence above shafts and small shaft in the form of a rectangle. Figure 1.3 shows the distribution of 54 sinkhole cases in classes of their length (the longest dimension on the surface) in 0.5 m intervals. In general, most of sinkhole cases have dimensions up to 3.0 m. An arithmetic mean of a sinkhole length amounts to 5.0 m, the minimum is 0.5 m and the maximum 17 m. Instead, a mean width amounts to 3.6 m, the minimum width is 0.3 m, and the maximum width is 12 m.

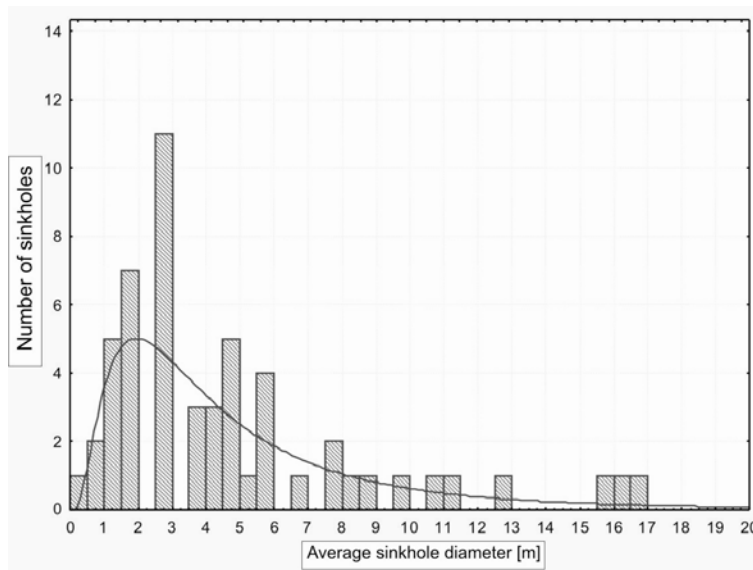

Fig. 1.3. Distribution of sinkhole cases number in length classes, with 0.5 m interval (approximation by a lognormal distribution) in the period 1963–2007

Rys. 1.3. Rozkład ilości zapadlisk w klasach długości z interwałem co 0,5 m (aproxymacja rozkładem lognormalnym) w latach 1963–2007

When analysing the sinkhole clusters by length and width, it should be noted that for the adopted normal distribution their sizes concentrate in intervals up to 6.0 m in terms of length and width (Fig. 1.4).

51 documented phenomena from the period 1963–2007 were used to analyse the sinkhole depth distribution. Fig. 1.5 shows that most of sinkhole cases are up to 2.0 m deep, what statistically makes approx. 67% of the entire population.

An average sinkhole depth amounts to 2.4 mm, the minimum depth is 0.2 m, and the maximum depth 8.5 m. More detailed data is specified in Table 1.1.

A relatively small set of discontinuous deformations of linear nature, comprising 10 phenomena, has been analysed. Two characteristic groups of trenches and fissures exist – one of length not exceeding 20 m and the other of lengths in the range from 70 to 100 m. The longest was the trench, which occurred in spring 1966 in the area of Bytomska street in the southern part of Piekary Śląskie. More detailed data is specified in Table 1.2.

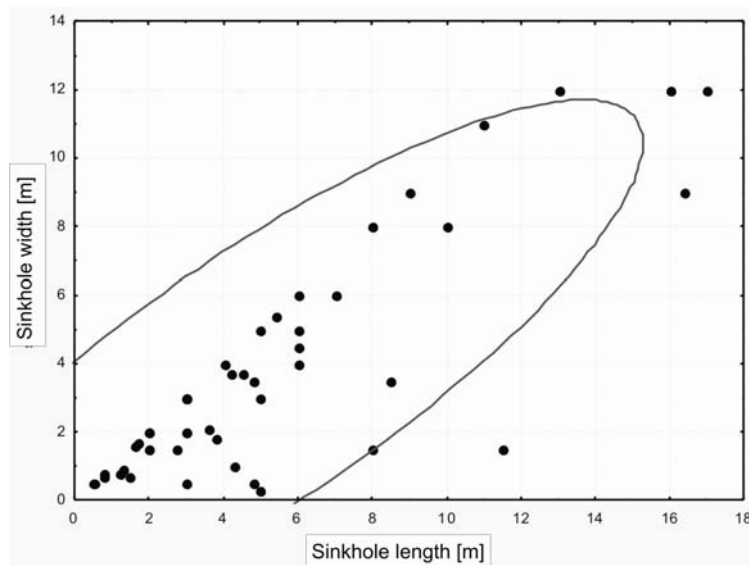

Fig. 1.4. Graph of sinkhole cases length and width with marked ellipsis of normal distribution fit at the confidence level of 0.95

Rys. 1.4. Wykres rozrzutu długości i szerokości zapadlisk z zaznaczoną elipsą dopasowania do rozkładu normalnego na poziomie ufności 0,95

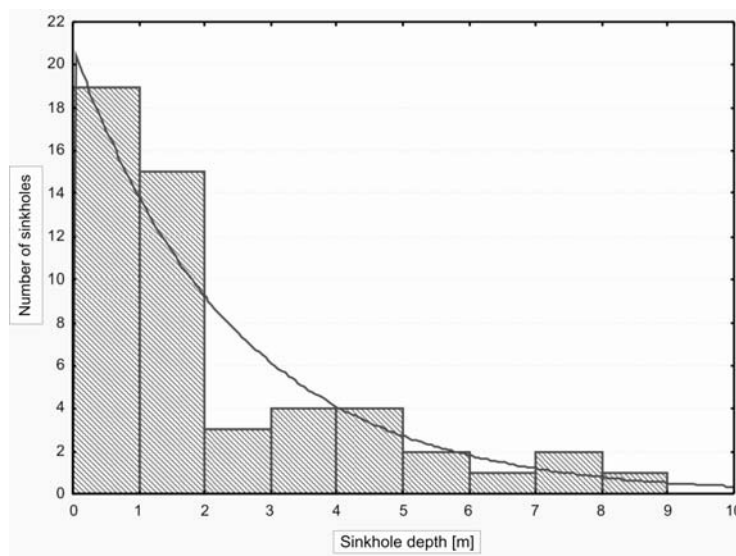

Fig. 1.5. Distribution of the number of sinkhole cases in depth classes with 1 m interval (approximation by an exponential distribution)

Rys. 1.5. Rozkład ilości zapadlisk w klasach głębokości z interwałem co 1 m (aproxymacja rozkładem wykładniczym)

TABLE 1.1

Specification of the number of sinkhole cases broken down by depth classes with 1 m interval and percentage share in the set of analysed sinkhole cases

TABELA 1.1

Zestawienie ilości zapadlisk w podziale na klasy głębokości z interwałem co 1m oraz procentowym udziale w zbiorze analizowanych zapadlisk

Depth class	Number of sinkhole cases	Percentage share of class [%]
0–1 m	19	37.25
1–2 m	15	29.41
2–3 m	3	5.88
3–4 m	4	7.84
4–5 m	4	7.84
5–6 m	2	3.92
6–7 m	1	1.96
7–8 m	2	3.92
8–9 m	1	1.96
>9 m	0	0

TABLE 1.2

Specification of the number of linear discontinuous deformations (trenches or fissures) in length classes with 10 m interval

TABELA 1.2

Zestawienie ilości deformacji nieciągłych liniowych (rowy lub szczeliny) w klasach długości z interwałem co 10 m

Length class	Number of sinkhole cases	Percentage share of class [%]
0–10 m	2	20
10–20 m	2	20
20–30 m	0	0
30–40 m	0	0
40–50 m	0	0
50–60 m	0	0
60–70 m	0	0
70–80 m	2	20
80–90 m	1	10
90–100 m	3	30
> 100 m	0	0

The analysis of data presented shows that the largest number of sinkhole cases has dimensions up to 3.0 m, while most of them occur in 2.5 m to 3.0 m class. A characteristic sinkhole in the Bytom basin on average is 5.0 m long, 3.6 m wide and 2.4 m deep. Theoretically, the largest sinkhole may be 17.0 m long, 16.0 m wide and 9.0 deep. It is difficult to determine similar parameters for linear discontinuous deformation due to a small size of the analysed set.

2. Assumptions of basement treatment methodology

In conditions of sinkhole threat in the areas of shallow mining in the Upper Silesia the injection method is used due to the need of directing the backfilling material to voids and loose zones in the rock mass. The backfilling material should be resistant to factors activating the sinkhole process. Relatively permanent effects of good interaction with the environment are obtained by means of materials based on binding slurries of strength close to the rock mass strength.

In general, the assumptions of the basement treatment methodology on the route of A-1 motorway in the sections threatened with discontinuous deformations are as follows:

1. Performing inspection boreholes with acquisition of the core or taking samples in specified places, enabling the application of backfilling technology. The borehole diameter should ensure a possibility to perform measurements using a borehole georadar and possibly a borehole camera. The cores should be photographed with an eligible description. The drilling works should be carried out under supervision of an authorised geologist.

2. Performing coreless inspection boreholes in places of sinkhole stated above shafts and small shafts as well as in places of post-mining infrastructure facilities parts, indicating the existence of shafts and small shafts in the past, to evaluate the degree of fill material consolidation. Such boreholes should be performed under supervision of an authorised geologist.

3. Performing measurements of location and size of voids and loose zones in the rock mass around boreholes by means of a borehole georadar and sections of the borehole not protected by a casing pipe should be recognised by a borehole camera. In the cases of recognition of voids having no contact with the drilled borehole, an additional borehole should be performed to force the backfilling material.

4. The forcing of backfilling material through the inspection borehole acc. to technology adapted to the determined geological and mining conditions. The decision on detailed technology of substrate treatment is made by the site manager in consultation with the authorised geologist supervising the works, having performed an inspection borehole and planned geophysical borehole examinations. In the backfilling boreholes, the injections of backfilling material should be completed at a distance of around 1.0 to 1.5 m below the planned level of motorway structure strengthening bottom. Leaving the cores of injection openings, produced from a hardened injected material, of stiffness higher than the

surrounding environment, may result in a disturbance of the continuity of structure strengthening performed at a later stage.

5. Performing secondary geophysical measurements to evaluate the filling effectiveness for voids and loose zones using identical methods as at the preliminary stage.

6. In any case, shaft excavations should be covered using a reinforced concrete slab. In sections, where there is a high density of small shafts, of difficult to reproduce location, the use of a vibration roller should be considered.

The basement treated should be protected against uncontrolled infiltration of rainwater as well as other factors, which could affect development of deformation in the zone close to the ground of the rock mass.

The works treating the basement as well preceding proper repair activities should be performed observing special safety measures. Because it cannot be excluded, that in places selected as potential sinkhole zones, the rock mass is in a limit state. In the event of such situation occurrence, all the works carried out on the ground surface may activate the sinkhole, what creates a safety hazard for people and equipment work. Having that in mind, the works in the area of potential sinkhole cases (in particular in shaft places) should be carried out using specially prepared platforms, founded on a stable basement outside a possible reach of the sinkhole.

3. Geophysical method of basement treatment effectiveness improvement

The condition of rock mass in the neighborhood of inspection boreholes designated to introduce the backfilling material may be recognised using many methods, in particular geophysical, including also a borehole camera. To this end methods of borehole geophysics may be applied as well as various methods of seismic and georadar scanning or electric resistance probing.

In the conditions of basement treatment for A-1 motorway structure an assumption was made that basic methods used for optimisation of basement treatment consist of the gravimetric and georadar methods and also in appropriate conditions the introsopic method by means of a TV camera. The application of gravimetric method is related to diversification of soil density due to voids and loose zones existence in the basement. In such conditions negative gravimetric anomalies are recorded. The amplitude of those anomalies depends on geometrical parameters of post-mining voids or shafts and the degree of their filling. Depending on the degree of backfilling, changes in the amplitude size are recorded, corresponding to the difference between the density of material filling the void or loose zone and the average density of the surrounding environment. A positive anomaly may be recorded, e.g. where the material used for shaft backfilling has a higher density than the surrounding rocks.

A borehole georadar measurement is an efficient and relatively economical method for the rock mass condition recognition. It enables non-invasive recognition within the radius of

a few or dozen or so meters from the borehole, depending on the applied frequency of the antenna and on the measuring conditions (Fig. 3.1). The result of this measurement supplemented with geological information acquired during drilling and the information from a borehole camera should provide a satisfactory answer to the location of voids and loose zones or their absence.

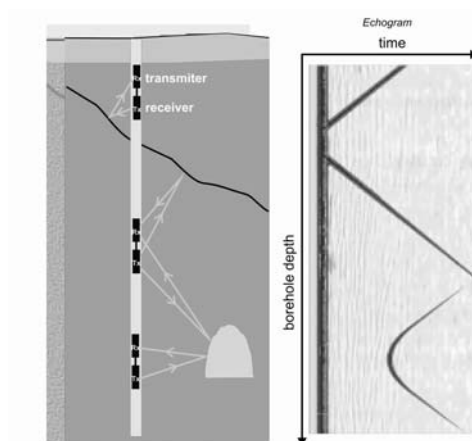

Fig. 3.1. Recognition of empties and discontinuities by the help of borehole georadar (on the basis of Mala Geosciences)

Rys. 3.1. Sposób rozpoznania pustek i nieciągłości za pomocą georadaru otworowego (na podstawie Mala Geosciences)

The measurement with a borehole georadar is based on the same principles as the measurement by a georadar on the ground surface. This means that a borehole georadar consists of a transmitting and receiving antennas. Antennas are connected by an optical cable with the control unit, which generates signals and records signals – answers. The georadar method uses the phenomenon of high frequency, of the order of tens MHz, electromagnetic impulses propagation, reproducing the variability of electrical properties and the structure of various material environments.

A borehole georadar may be used in various measuring techniques: reflective, scanning between boreholes or surface-borehole scanning. For the needs of recognition in highly cracked carbonate formations, considering the quality of recognition vs. the penetration reach, a 100 MHz antenna should be applied.

The measurement by a TV camera allows visual observation of the borehole interior, in particular the depths of lithological boundaries location, the zones of cracks and their sizes, the way of environment waterlogging, voids shape and size, degree of voids filling during the backfilling (Krzyszowicz 2001). The quality of observations in a borehole depends on such conditions as the moisture content, dustiness, temperature or pressure difference.

The borehole probe is equipped with two miniature observation cameras: vertical and horizontal. The examined objects are illuminated by means of diodes within the infrared

range and by a strong halogen lamp (Fig. 3.2). A typical probe allows examining boreholes up to 100 m deep, with accuracy of ± 0.05 m. Sizes are measured with accuracy of ± 0.01 m. The image and sound are digitally recorded. To present photographs of selected borehole parts, the completely measured record is analysed, with computer registration of eligible parts of the image and selection of single frames. The photographs selected are processed and noise-filtered by means of specialised software. The computer processing, interpretation and description is based on the knowledge of rocks geology, fissures, information on mining conditions etc.

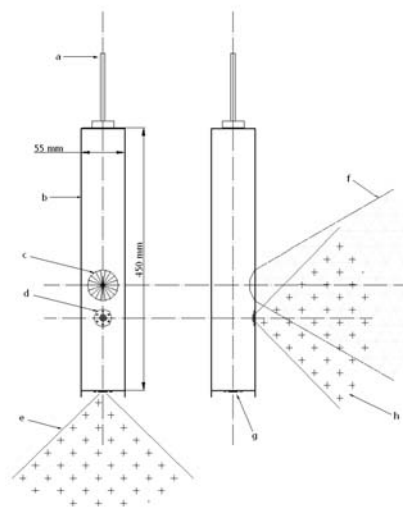

Fig 3.2. Diagram of borehole probe

a) introduction of control and supply cables, b) tubular camera housing, c) strong halogen light, d) side camera, illuminating diodes, e) field of view of the bottom camera, along the borehole, f) beam of halogen light, g) bottom camera, illuminating diodes, h) field of view of the side camera (Krzyszowicz 2001)

Rys. 3.2. Schemat sondy otworowej

a) wprowadzenie kabli sterujących i zasilających, b) tubus obudowy kamery, c) silne oświetlenie halogenowe, d) kamera boczna, diody oświetleniowe, e) pole widzenia kamery dolnej, wzdłuż otworu, f) snop oświetlenia halogenowego, g) kamera dolna, diody oświetleniowe, h) pole widzenia kamery bocznej (Krzyszowicz 2001)

The required diameter of boreholes is around 100 mm. Drilling with a drilling fluid in loose parts close to the surface (sands, gravels, embankments) should be avoided due to borehole walls deformation and washing out. Casing is then required and thereby examinations by a camera are impossible. Boreholes without casings are examined immediately after their drilling. The casing used, if needed, covers loose layers or embankments.

Frequently it is necessary to clean and redrill the boreholes, in the case of loose rocks rockfalls blocking the possibility to perform examinations. It happens mainly in the areas of cracks and during thick embankments drilling. In the case of voids the borehole should be cased after camera examinations up to the void's roof to preserve the borehole for void

liquidation. The specified geophysical methods have been used at the designing of basement treatment methodology. This methodology comprises the following stages:

Stage I – performance of gravimetric measurements in the immediate vicinity of the injection borehole prior to the introduction of the backfilling material. The measuring points should be determined by the geodetic method and specially stabilised. The results of gravimetric measurements performed during the recognition of sinkhole threat may be used. Two intersecting measuring profiles are performed in the gravimetric method, at the point of borehole performance, 50 m long, and 25 m on each side. The number of gravimetric measurement points for a specific borehole depends on its depth, but primarily on the depth of voids and loose zones situation. This depth may vary within the range from a few metres to around 50–60 m. Therefore the number of measuring points in the designed arrangement varies from 17 to a few dozens.

Stage II – performance of georadar recognition in the inspection borehole to determine the location of voids or loose zones. Georadar measurements should also indicate voids and loose zones, if any, in the immediate vicinity of the borehole, which are not visible in the borehole. In such cases additional injection boreholes should be performed. In geological conditions of A-1 motorway basement the reach of recognition around the inspection boreholes amounts to 5–10 m for a 100 MHz aerial. In the case of very shallow boreholes up to 6–10 m, the examinations may be carried out using a surface georadar. In conditions of unstable borehole walls, a PVC tube should be introduced, not smaller than 100 mm in diameter. In boreholes that do not require a casing pipe, the rock mass condition should be additionally checked with a borehole camera to estimate volumes of voids and loose zones.

Stage III – after completion of injection works gravimetric measurements should be performed in identical places like before the introduction of the backfilling material. The differences in anomalies sizes inform about the effectiveness of injection works. At the interpretation stage, preparation of graphs showing differences in Bouger anomalies distribution before and after backfilling is sufficient to evaluate the quality of basement protection.

The methodology presented allows more precise localisation of voids or loose zones around the borehole. It should be emphasised that an inspection borehole may pass by a void or loose zone and they may be invisible in the borehole. Measurements with a borehole georadar, providing recognition of a zone around the borehole within a radius from a few to a dozen or so meters, to a large extent should limit such cases.

If the performance of gravimetric measurement is impossible, then it is necessary, depending on measuring conditions, to carry out measurements using the seismic, georadar or electric resistance methods.

The recognition of weakened zones around the borehole using the georadar method will also allow improving the effectiveness of basement treatment as a result of improvement in backfilling effectiveness.

Summary

In the areas of planned A-1 motorway comprising shallow mining of metal ores deposits, discontinuous deformations related to this mining occur in various forms even despite the passage of more than 100 years from the end of mining. Various old sinkhole forms visible now on the ground surface, most frequently above shafts and small shafts, and also the results of geophysical recognition indicate the need of performing the treatment of A-1 motorway structure basement. The threat with discontinuous deformations should be limited by backfilling the voids and loose zones using a backfilling material and special protection of A-1 motorway structure. To this end inspection boreholes should be drilled in places of selected geophysical anomalies, fault zones and in places of sinkhole cases and parts of post-mining infrastructure facilities observed on the ground surface, indicating the existence of shafts and small shafts in the past. The stated voids and loose zones should be backfilled using a backfilling material properly selected to the geological and mining conditions. Geophysical methods should be used for as optimum as possible recognition of voids and loose zones location in immediate vicinity of inspection boreholes. The gravimetric method, applied in two series – before and after material forcing, is the basic method to evaluate the backfilling effectiveness. The method of borehole georadar is used to determine the position around the borehole of voids and loose zones, even invisible in the borehole. A micro camera should be used to check voids available in the borehole.

The application of geophysical methods should contribute to the improvement in effectiveness of basement treatment and to definite reduction of the risk of A-1 motorway structure damage in the case of discontinuous deformations occurrence.

REFERENCES

- Bratasz T. (ed.), 1990 – Problematyka ochrony powierzchni terenu miasta Piekary Śląskie w związku z likwidacją kopalni rud cynku i ołowiu „Orzeł Biały”. Dokumentacja ZGH „Orzeł Biały”, Bytom (praca niepubl.).
- Krzyszowski M., 2001 – Możliwości zastosowania mikrokamery otworowej do badań na terenach płytkiej eksploatacji górniczej – przykłady. Sprawozdania z posiedzeń komisji naukowych PAN, Kraków, t. XLV/1, 220–225.
- Kubański A., 2007 – Drogi na pustkach. Uzdatnianie zniszczonego robotami górniczymi podłoża do budowy tras komunikacyjnych. Nowoczesne Budownictwo Inżynieryjne, IX–X.
- MALA Geoscience <http://www.malags.com/>
- Pilecki Z., 2008 – The role of geophysical methods in the estimation of sinkhole threat in the post-mining areas of shallow exploitation in the Upper Silesian Coal Basin, Poland. *Gospodarka Surowcami Mineralnymi* t. 24, z. 3/1, 27–40.
- Pilecki Z. (ed.), 2007 – Program uzdatnienia podłoża metodą podsadzenia pustek na odcinkach zagrożonych deformacjami nieciągłymi na trasie projektowanej autostrady A-1. Dokumentacja badań, KBPDIM Transprojekt, Kraków (praca niepubl.).
- Pilecki Z., Kocyba A., 2007 – Problematyka rozpoznania deformacji nieciągłych dla potrzeb projektowania konstrukcji drogowych na terenie płytkiej eksploatacji rud metali. *Prace Naukowe GIG Nr III/2007*, wyd. spec., 379–392.

- Popiołek E., Pilecki Z. (ed.), 2005 – Ocena przydatności do zabudowy terenów zagrożonych deformacjami nieciągłymi za pomocą metod geofizycznych. Wyd. IGSMiE PAN, Kraków.
- Marcak H., Pilecki Z., 2006 – Some Geophysical and Geomechanical Remarks on Recognition Sinkhole Processes in Post-Mining Areas. Proc. 12th European Meeting of Environmental and Engineering Geophysics. 4–6 September, Helsinki, Finland.

METHODOLOGY FOR A-1 MOTORWAY BASEMENT TREATMENT EFFECTIVENESS IMPROVEMENT BY MEANS OF GEOPHYSICAL METHODS IN THE AREAS OF METAL ORES SHALLOW MINING THREATENED WITH THE SINKHOLE OCCURRENCE IN THE UPPER SILESIA

Key words

Microgravimetry, borehole georadar, micro camera, basement treatment, sinkhole threat, post-mining terrains

Abstract

The methodology for A-1 motorway basement treatment, using geophysical methods in the area of former historical shallow mining of zinc and lead as well as iron ores threatened with the occurrence of sinkhole within the Bytom basin in the Upper Silesia, has been presented. The method discussed consists in carrying out properly designed geophysical examinations using gravimetric, borehole georadar and micro camera introscopy methods. The paper presents the assumptions of the A-1 motorway basement treatment methodology preceded by the description of the sinkhole threat. Detailed methodology for geophysical measurements adapted to the basement treatment methodology has been presented. Stages of recognition of voids and loose zones location in the vicinity of injection holes have been characterised as well as the way of basement backfilling effectiveness evaluation. The solutions discussed are aimed at as effective as possible limitation of the threat of A-1 motorway structure damage.

METODYKA POPRAWY EFEKTYWNOŚCI UZDATNIENIA PODŁOŻA AUTOSTRADY A-1 ZA POMOCĄ METOD GEOFIZYCZNYCH NA TERENACH PŁYTKIEJ EKSPLOATACJI RUD METALI ZAGROŻONYCH WYSTĄPIENIEM ZAPADLISK NA GÓRNYM ŚLĄSKU

Słowa kluczowe

Mikrograwimetria, georadar otworowy, mikrokamera, uzdatnianie podłoża, zagrożenie zapadliskowe, tereny pogórnice

Streszczenie

Przedstawiono metodykę uzdatnienia podłoża autostrady A-1 z zastosowaniem metod geofizycznych na terenie pogórnym, historycznej, płytkiej eksploatacji rud cynku i ołowiu oraz żelaza zagrożonych wystąpieniem zapadlisk w rejonie niecki bytomskiej na Górnym Śląsku. Omówiony sposób polega na przeprowadzeniu odpowiednio zaprojektowanych badań geofizycznych za pomocą metod grawimetrycznej, georadarowej otworowej i introskopowej mikrokamerą. W artykule przedstawiono założenia metodyki uzdatniania podłoża autostrady A-1 poprzedzone charakterystyką zagrożenia zapadliskowego. Przedstawiono szczegółową metodykę pomiarów geofizycznych w dostosowaniu do metodyki uzdatnienia podłoża. Scharakteryzowano etapy rozpoznania położenia pustek i stref rozluźnienia w sąsiedztwie otworów iniekcyjnych oraz sposób oceny efektywności podsadzenia podłoża. Celem omówionych rozwiązań jest możliwie efektywne ograniczenie zagrożenia zniszczeniem konstrukcji autostrady A-1.

